

BLOCK DIAGRAM

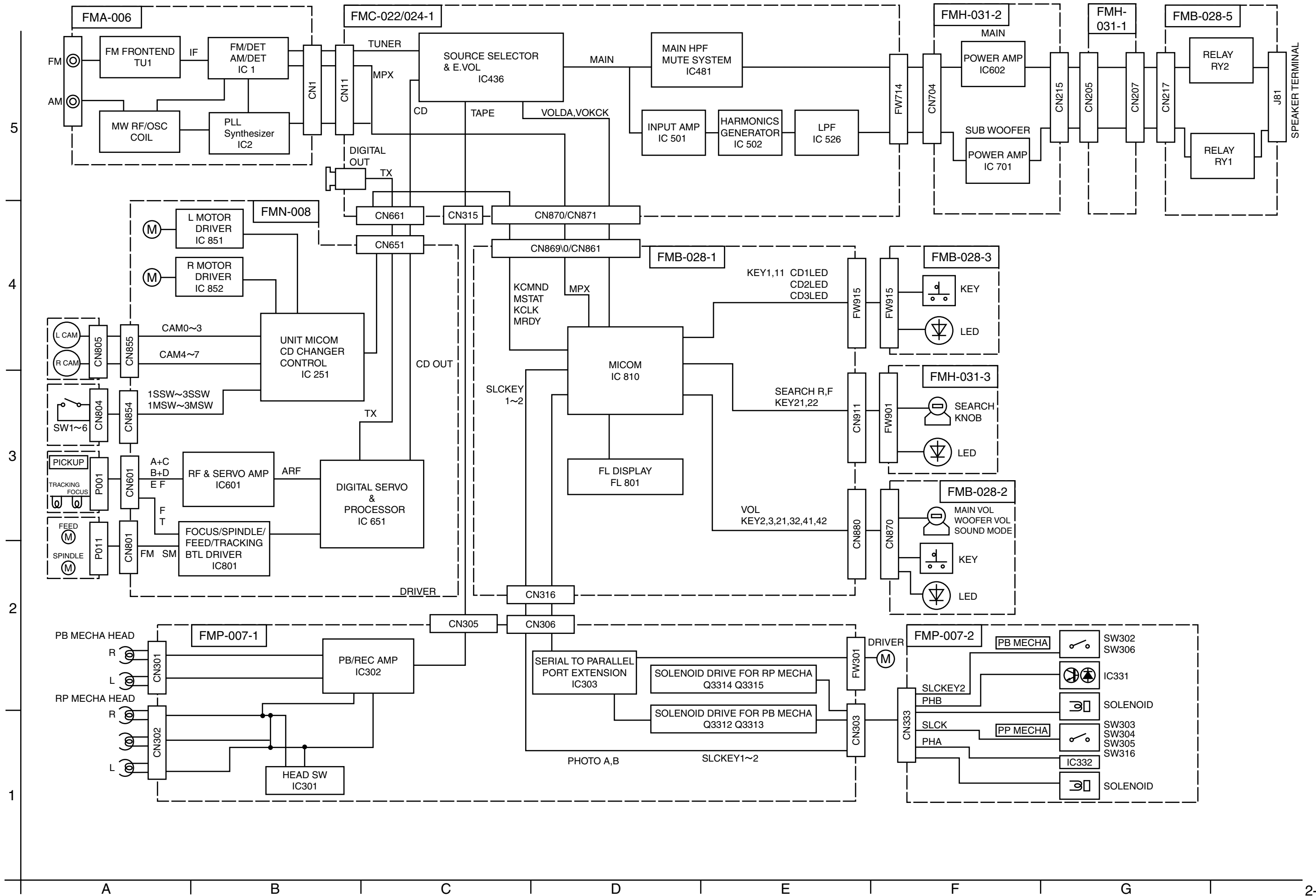

Standard schematic diagrams

Power supply section (MX-GT80)

POWER SUPPLY BLOCK

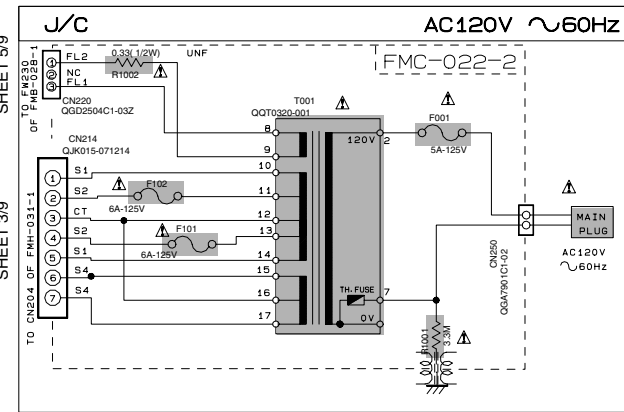

POWER SUPPLY BLOCK

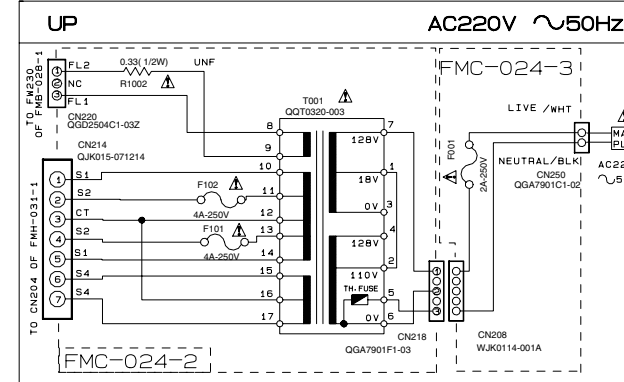

POWER SUPPLY BLOCK

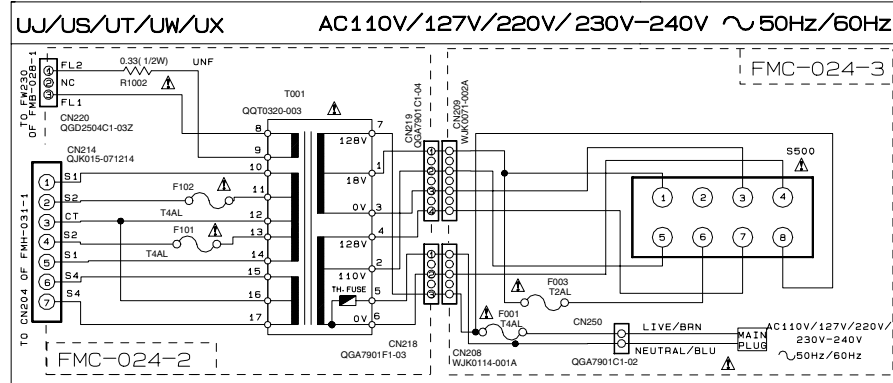

VOLTAGE SELECTOR LOCATION

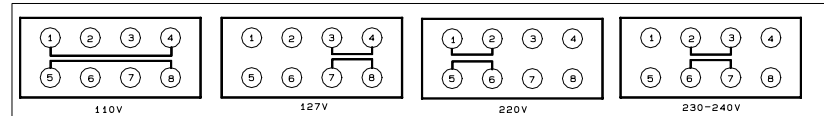

POWER SUPPLY BLOCK

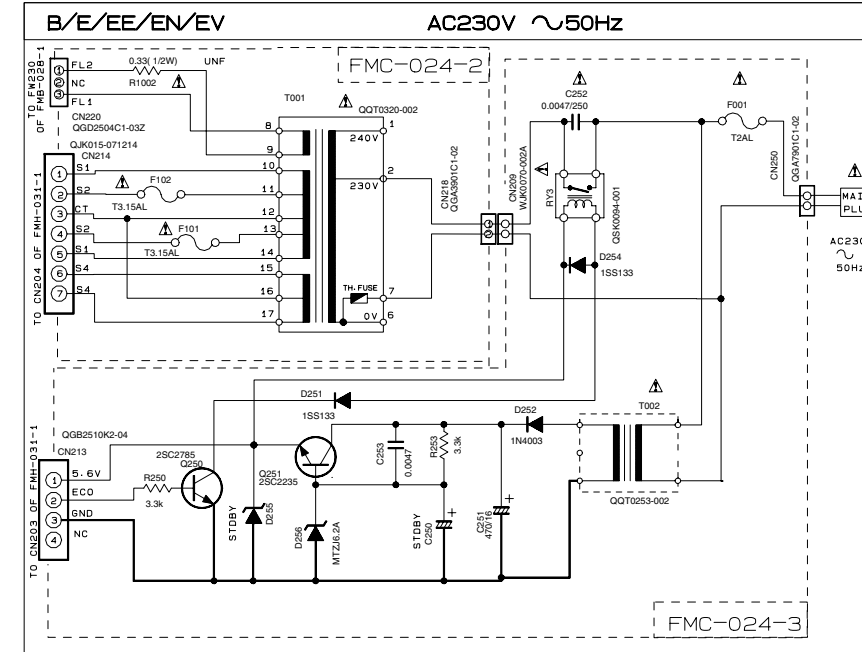

POWER SUPPLY BLOCK

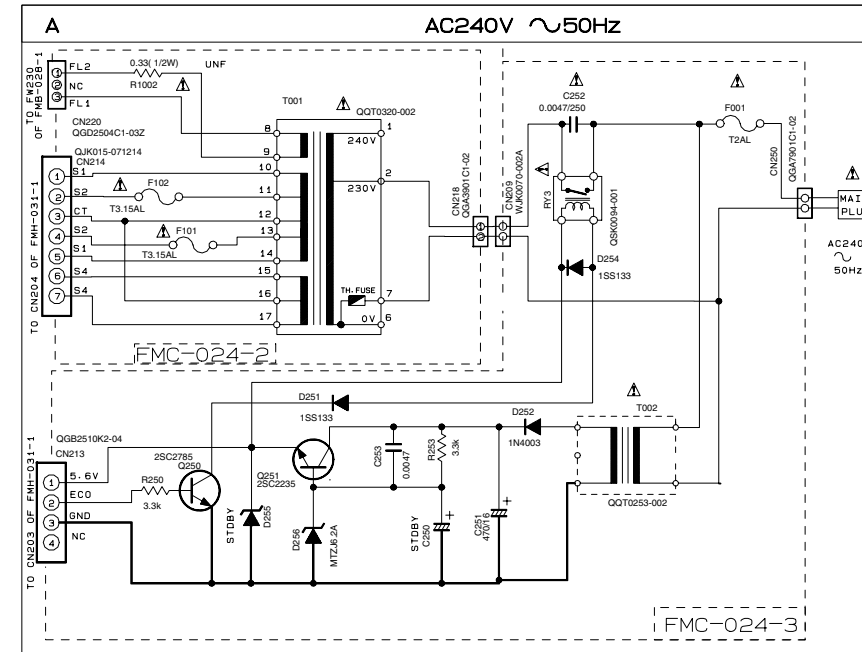

POWER SUPPLY BLOCK

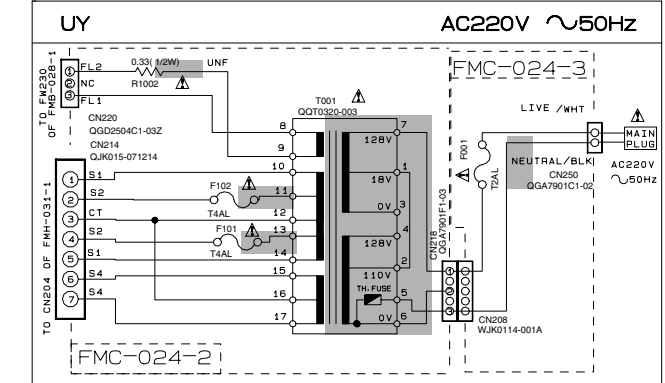

EXPLANATION OF OVERALL OF SCHEMA.

MODEL MX-GT80/MX-GT90

SHEET NUMBER	MODEL NUMBERS TO BE APPLIED	CIRCUITS DESCRIPTION
1/9	MX-GT80	PRIMARY WITH MAINS TRANSFORMER
2/9	MX-GT90	PRIMARY WITH MAINS TRANSFORMER
3/9	MX-GT80/MX-GT90	DC REGULATORS/AUDIO OUTPUT
4/9	MX-GT80/MX-GT90	EXTERNAL INPUT, SOURCE SELECTOR SWITCH
5/9	MX-GT80/MX-GT90	FL DISPLAYS, SYSTEM CONTROL LSI
6/9	MX-GT80/MX-GT90	USER CONTROL KEYS, MIC AMP
7/9	MX-GT80/MX-GT90	CD SERVO AND CD SYSTEM CONTROL CD CHANGER MECHANISM CONTROL
8/9	MX-GT80/MX-GT90	TAPE DECK MECHANISM CONTROL TAPE CIRCUITS SUCH AS PRE-AMP AND BIAS
9/9	MX-GT80/MX-GT90	TUNER RF/1F/FM MULTIPLEX

VERSION CODES

- J : U. S. A.
- C : CANADA
- B : U. K.
- E : CONTINENTAL EUROPE
- EE : RUSSIA
- EN : NORDIC COUNTRIES
- EV : EASTERN EUROPE
- A : AUSTRALIA
- UJ : MILITARY
- UP : KOREA
- UT : TAIWAN
- UX : SAUDI ARABIA
- UY : ARGENTINA
- UW : SOUTH AMERICA EXCEPT ARGENTINA
- US : SINGAPORE AND UNIVERSAL EXCEPT ALL OF ABOVE

Parts are safety assurance parts. When replacing those parts make sure to use the specified one.

■ Power supply section (MX-GT90)

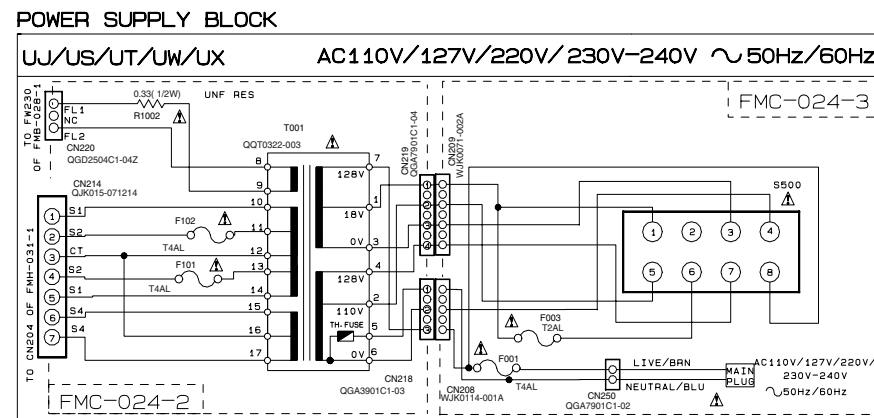
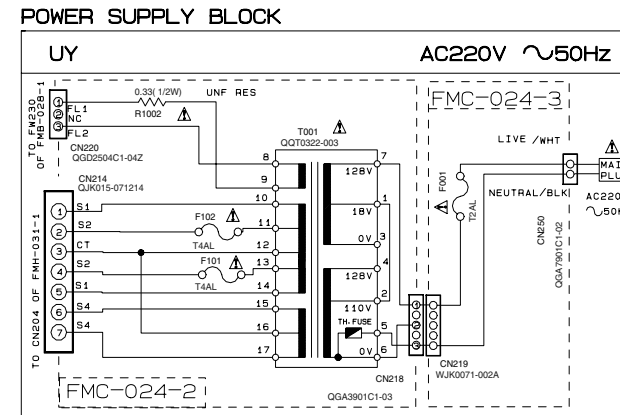
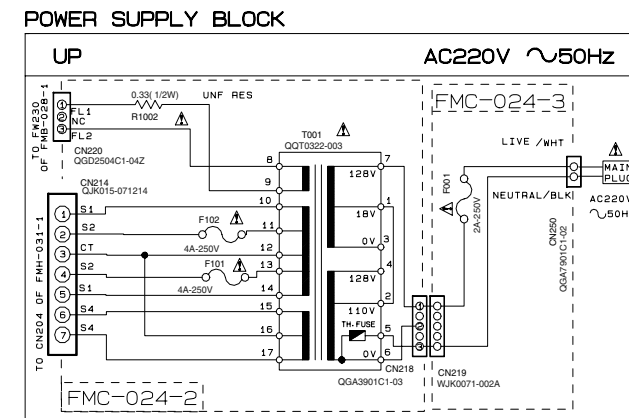
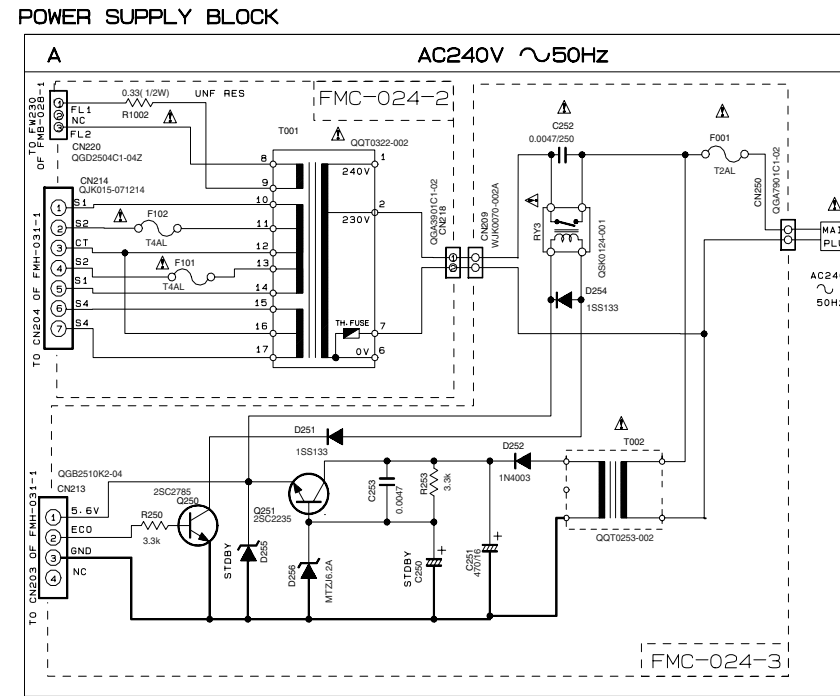
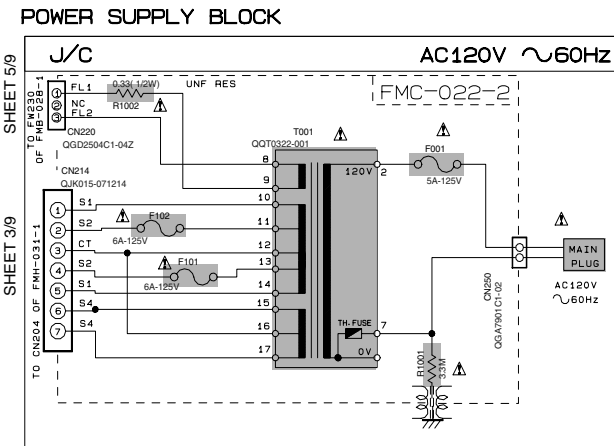

VERSION CODES

- J : U.S.A.
- C : CANADA
- A : AUSTRALIA
- UJ : MILITARY
- UP : KOREA
- UT : TAIWAN
- UX : SAUDI ARABIA
- UY : ARGENTINA
- UW : SOUTH AMERICA EXCEPT ARGENTINA
- US : SINGAPORE AND UNIVERSAL EXCEPT ALL OF ABOVE

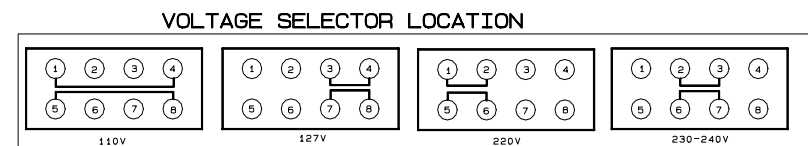

▲ Parts are safety assurance parts.
When replacing those parts make sure to use the specified one.

5

4

3

2

1

DC regulation & audio output section

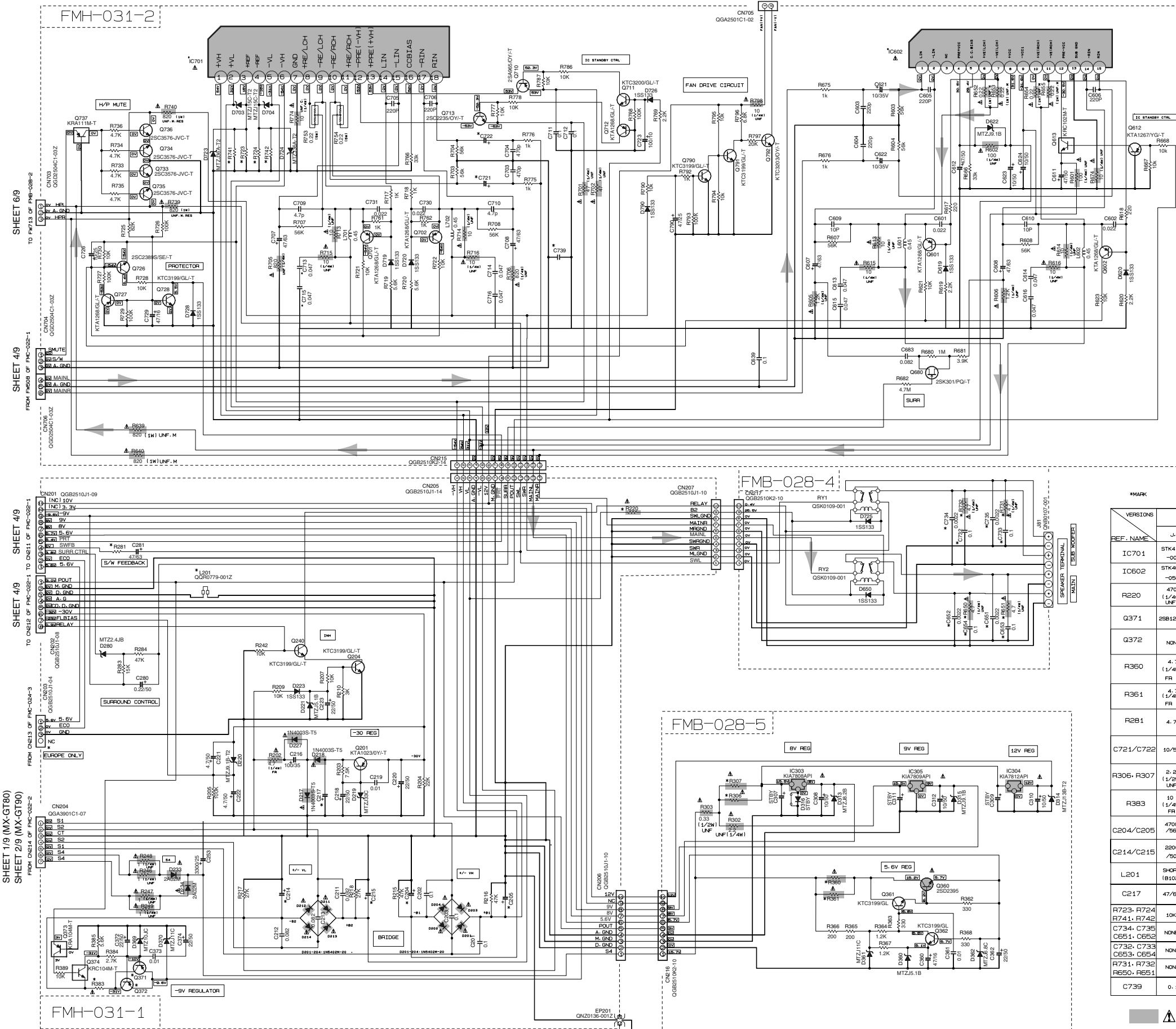

NOTES
 1. VOLTAGES ARE DC-MEASURED WITH A DIGITAL VOLT METER OR OSCILLOSCOPE WITHOUT INPUT SIGNAL.
 CONDITION — AUX MODE — VOL NORM — BASE OFF
 2. UNLESS OTHERWISE SPECIFIED
 RESISTORS ARE 1/4W ± 5% CARBON RESISTOR.
 ALL RESISTANCE VALUES ARE IN OHM Ω.
 ALL CAPACITORS ARE CERAMIC CAPACITOR OR MYLAR CAPACITOR.
 ALL CAPACITANCE VALUES ARE IN nF(pF).
 ALL INDUCTANCE VALUES ARE IN mH(mH).
 ALL ELECTROLYTIC CAPACITORS ARE SHOWN IN THE FORM OF CAPACITANCE (μF)/RATED VOLTAGE (V).
 ALL DIMENSIONS ARE IN MILLIMETERS.

VERSIONS	MX-G70				MX-GT80				MX-GT90			
	J-C	A-E	U	UT	J-C	A-E	U	UT	J-C	A	U	UT
IC701	STK412-000	STK412-090	STK412-090	STK412-010	STK412-010	STK412-000	STK412-000	STK412-020	STK412-010	STK412-010	STK412-010	STK412-010
IC602	STK402-050	STK402-030	STK402-030	STK402-030	STK402-030	STK402-030	STK402-030	STK402-070	STK402-030	STK402-030	STK402-050	STK402-050
R220	470 (1/4W) UNF	150 (1/4W) UNF	150 (1/4W) UNF	150 (1/4W) UNF	470 (1/4W) UNF	150 (1/4W) UNF	150 (1/4W) UNF	470 (1/4W) UNF	150 (1/4W) UNF	150 (1/4W) UNF	150 (1/4W) UNF	150 (1/4W) UNF
Q371	2SB1274	NONE	NONE	NONE	2SB1274	NONE	NONE	2SB1274	NONE	NONE	NONE	NONE
Q372	NONE	KTA1023	KTA1023	KTA1023	NONE	KTA1023	KTA1023	NONE	KTA1023	KTA1023	KTA1023	KTA1023
R360	4.7 (1/4W) FR	2.2 (1/4W) FR	2.2 (1/4W) FR	2.2 (1/4W) FR	4.7 (1/4W) FR	2.2 (1/4W) FR	2.2 (1/4W) FR	4.7 (1/4W) FR	2.2 (1/4W) FR	2.2 (1/4W) FR	2.2 (1/4W) FR	2.2 (1/4W) FR
R361	4.7 (1/4W) FR	4.7 (1/4W) FR	4.7 (1/4W) FR	4.7 (1/4W) FR	4.7 (1/4W) FR	4.7 (1/4W) FR	4.7 (1/4W) FR	4.7 (1/4W) FR	4.7 (1/4W) FR	4.7 (1/4W) FR	4.7 (1/4W) FR	4.7 (1/4W) FR
R281	4.7K	4.7K	4.7K	4.7K	7.5K	5.6K	5.6K	5.6K	8.2K	5.6K	5.6K	5.6K
C721/C722	10/50	10/50	10/50	10/50	10/50	10/50	10/50	10/35	10/35	10/35	10/35	10/35
R306, R307	2.2 (1/2W) UNF	SHORT	SHORT	SHORT	2.2 (1/2W) UNF	SHORT	SHORT	2.2 (1/2W) UNF	SHORT	SHORT	SHORT	SHORT
R383	10 (1/4W) FR	SHORT (B123)	SHORT (B123)	SHORT (B123)	10 (1/4W) FR	SHORT (B123)	SHORT (B123)	10 (1/4W) FR	SHORT (B123)	SHORT (B123)	SHORT (B123)	SHORT (B123)
C204/C205	4700/50	4700/50	4700/50	4700/50	4700/50	4700/50	4700/50	4700/50	4700/50	4700/50	4700/50	4700/50
C214/C215	2200/50	2200/35	2200/35	2200/35	2200/50	2200/35	2200/35	2200/50	2200/50	2200/50	2200/50	2200/50
L201	SHORT (B102)	SHORT (B102)	SHORT (B102)	SHORT (B102)	SHORT (B102)	SHORT (B102)	SHORT (B102)	SHORT (B102)	SHORT (B102)	SHORT (B102)	SHORT (B102)	SHORT (B102)
C217	47/63	47/63	47/63	47/63	47/63	47/63	47/63	47/100	47/100	47/100	47/100	47/100
R723, R724	10K	6.8K	6.8K	6.8K	10K	6.8K	6.8K	10K	6.8K	6.8K	6.8K	6.8K
R741, R742	NONE	USE	NONE	NONE	NONE	USE	NONE	NONE	USE	NONE	NONE	NONE
C734, C735	NONE	USE	NONE	NONE	NONE	USE	NONE	NONE	USE	NONE	NONE	NONE
C651, C652	NONE	USE	NONE	NONE	NONE	USE	NONE	NONE	USE	NONE	NONE	NONE
C732, C733	NONE	USE	NONE	NONE	NONE	USE	NONE	NONE	USE	NONE	NONE	NONE
C653, C654	NONE	USE	NONE	NONE	NONE	USE	NONE	NONE	USE	NONE	NONE	NONE
R731, R732	NONE	USE	NONE	NONE	NONE	USE	NONE	NONE	USE	NONE	NONE	NONE
R650, R651	NONE	USE	NONE	NONE	NONE	USE	NONE	NONE	USE	NONE	NONE	NONE
C739	0.1	1/50	1/50	1/50	0.1	1/50	1/50	0.1	1/50	1/50	1/50	1/50

▲ Parts are safety assurance parts. When replacing those parts make sure to use the specified one.

5

4

3

2

1

A

B

C

2-4

D

E

F

G

H

Main section

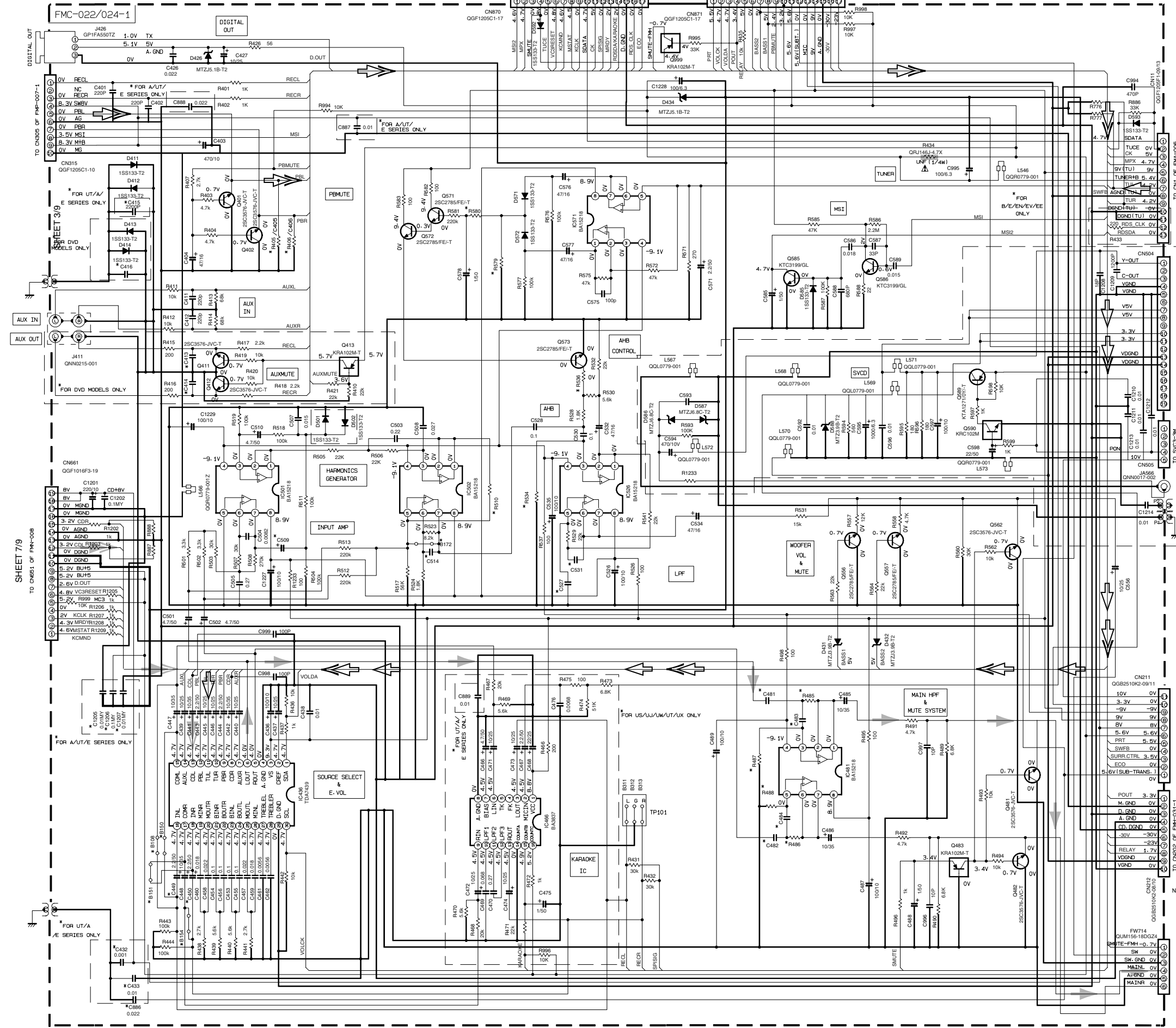

MODEL	CA-MXG70		MX-G70		CA-MXG71R	
VERSION	US/UM UX/UJ	UP/UY	UT	A	J/C	B/E EN/EE
R485/486			56K			
R487/488			82K			
C481/482 483/484			QFLM1HJ-223Z			
R536			15K			
C514			QFLM1HJ-473Z			
R510			100K			
C509			QETN1M-475Z			
R534			180K			
C531			QFVJ1HJ-274Z			
C527			QFLM1HJ-273Z			
R579			82K			
R580			2.2K			
C449	USED	NONE	USED	NONE		
C450	USED	NONE	USED	NONE		
B150	NONE	USED	NONE	USED		
B151	NONE	USED	NONE	USED		
B108	NONE	USED	NONE	USED		
B154	NONE	USED	NONE	USED		

MODEL	CA-MXG780		CA-MXG791R		
VERSION	J/C	US/UM UJ	UP/UY	A	B/E/EN EV/EE
R485/486			51K		
R487/488			130K		
C481/482 483/484			QFLM1HJ-273Z		
R536			12K		
C514			QFLC1HJ-471Z		
R510			100K		
C509			QETN1CM-106Z		
R534			180K		
C531			QFVJ1HJ-334Z		
C527			QFLM1HJ-103Z		
R579			100K		
R580			5.6K		
C449	NONE	USED	NONE	USED	NONE
C450	NONE	USED	NONE	USED	NONE
B150	USED	NONE	USED	NONE	USED
B151	USED	NONE	USED	NONE	USED
B108	USED	NONE	USED	NONE	USED
B154	USED	NONE	USED	NONE	USED

MODEL	MX-GT90		CA-MXG790	
VERSION	J/C	US/UM UJ	UP/UY	A
R485/486			56K	
R487/488			150K	
C481/482 483/484			QFZ0160-223Z	
R536			12K	
C514			QFLC1HJ-417Z	
R510			120K	
C509			QETN1CM-106Z	
R534			220K	
C531			QFVJ1HJ-184Z	
C527			QFLM1HJ-183Z	
R579			82K	
R580			680	
C449	NONE	USED	NONE	NONE
C450	NONE	USED	NONE	NONE
B150	USED	NONE	USED	USED
B151	USED	NONE	USED	USED
B108	USED	NONE	USED	USED
B154	USED	NONE	USED	USED

*R405/R406 = GRE141J-222Y (FOR OTHER THAN A-UT AND E SERIES)
 *C405/C406 = QCSB1HJ-102Y (FOR A-UT AND E SERIES ONLY)

- NOTES
- VOLTAGES ARE DC-MEASURED WITH A DIGITAL VOLT METER OR OSCILLOSCOPE WITHOUT INPUT SIGNAL.
 - CONDITION — AUX MODE, VOL. MIN., SUBWOOFER VOL. 1.
 - UNLESS OTHERWISE SPECIFIED:
 - RESISTORS ARE 1/4W 1% CARBON RESISTOR.
 - ALL RESISTANCE VALUES ARE IN OHM(S).
 - ALL CAPACITORS ARE CERAMIC CAPACITOR OR MYLAR CAPACITOR.
 - ALL CAPACITANCE VALUES ARE IN PICO(F).
 - ALL INDUCTANCE VALUES ARE IN MILLI(H).
 - ALL E-CAPACITORS ARE SHOWN IN THE FORM OF CAPACITANCE (μF)/RATED VOLTAGE (V).
 - ALL DIODES ARE 1SS133

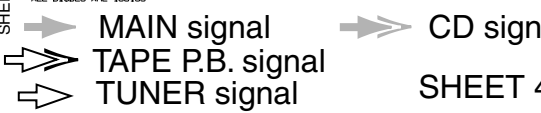

FL & system control section

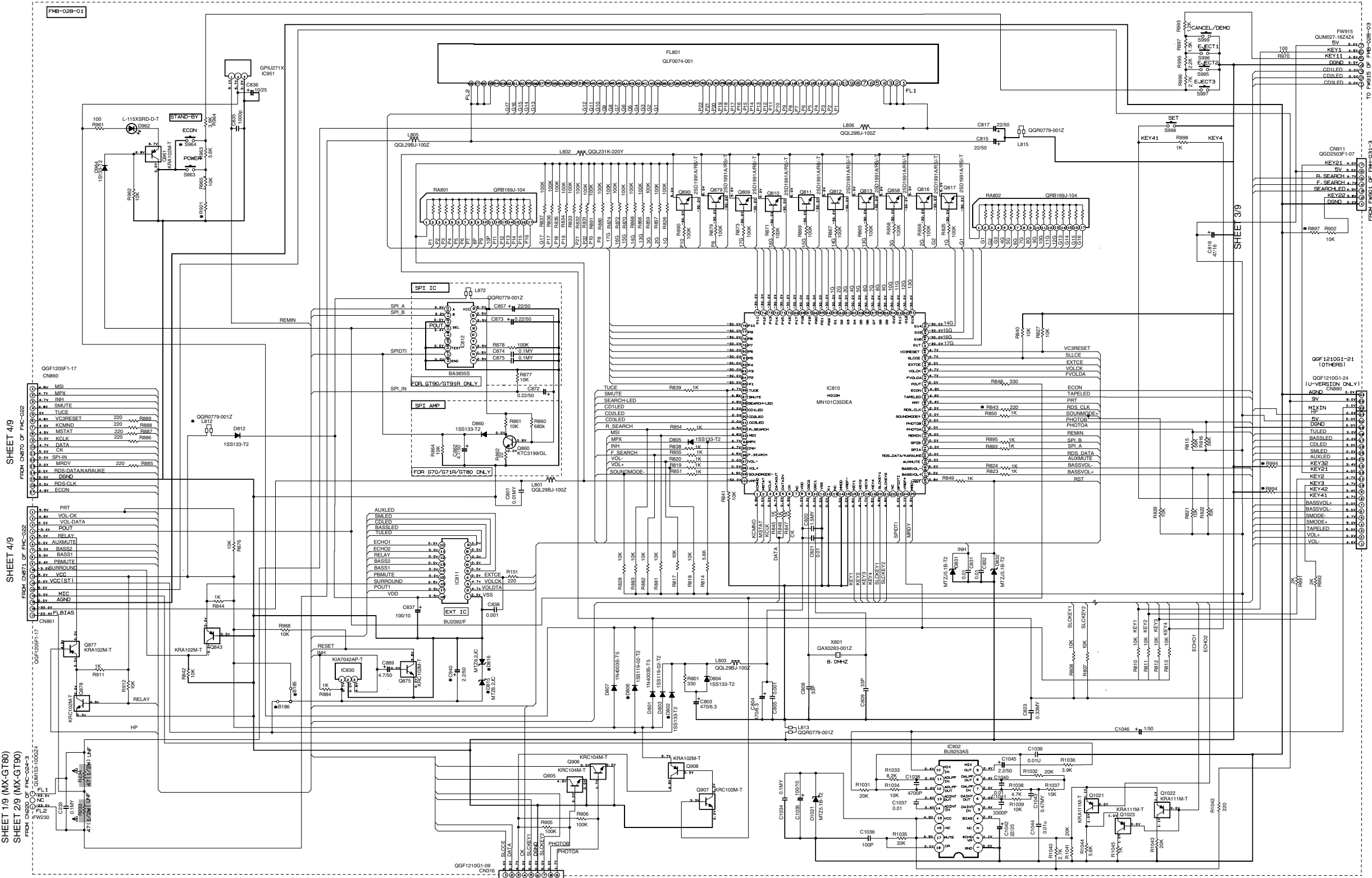

MARK

	CA-MXGT80 B-E-EN-EV	CA-MXGT90 A	MX-GT80 J-C	CA-MXGT90 UX	CA-MXGT90 UJ-UP-US-UT-UW	CA-MXGT90 UY	MX-GT90 E-E	CA-MXGT91R UJ-UP-US-UT-UW	MX-GT91R E-E	CA-MXGT90 UJ-UP-US-UT-UW	MX-GT90 C-J	CA-MXGT90 B-E-EN-EV	CA-MXGT90 A	CA-MXGT90 UY	CA-MXGT90 UJ-UP-US-UT-UW	MX-GT90 C-J	MX-GT90 A	MX-GT90 UY
R821	330K	330K	330K	330K	330K	330K	330K	75K	75K	75K	75K	75K	75K	18K	18K	18K	18K	
R897	330K	75K	75K	75K	75K	75K	75K	330K	75K	330K	75K	75K	75K	75K	75K	75K	75K	
R894	75K	330K	75K	18K	75K	75K	75K	75K	75K	330K	75K	75K	75K	330K	75K	330K	75K	
R894	330K	330K	75K	18K	330K	18K	75K	330K	75K	330K	18K	330K	75K	330K	75K	330K	18K	
R843	NONE	NONE	NONE	NONE	NONE	NONE	NONE	NONE	NONE	NONE	NONE	NONE	NONE	NONE	NONE	NONE	NONE	
X801	GAX0283-0012	GAX0283-0012	GAX0283-0012	GAX0283-0012	GAX0283-0012	GAX0283-0012	GAX0283-0012	GAX0283-0012	GAX0283-0012	GAX0283-0012	GAX0283-0012	GAX0283-0012	GAX0283-0012	GAX0283-0012	GAX0283-0012	GAX0283-0012	GAX0283-0012	
S964	GSW0674-0012	GSW0674-0012	NONE	NONE	NONE	NONE	NONE	NONE	NONE	NONE	NONE	NONE	NONE	NONE	NONE	NONE	NONE	
D802	1SS133-T2	1SS133-T2	NONE	NONE	NONE	NONE	NONE	1SS133-T2	NONE	NONE	NONE	NONE	NONE	NONE	NONE	1SS133-T2	NONE	
D806	1SS119-Q2-T2	1SS119-Q2-T2	NONE	NONE	NONE	NONE	NONE	1SS119-Q2-T2	NONE	NONE	NONE	NONE	NONE	NONE	NONE	1SS119-Q2-T2	NONE	
B196	NONE	NONE	NONE	NONE	NONE	NONE	NONE	NONE	NONE	NONE	NONE	NONE	NONE	NONE	NONE	NONE	NONE	
B196	USE	USE	NONE	NONE	NONE	NONE	NONE	USE	NONE	NONE	NONE	NONE	NONE	NONE	NONE	NONE	NONE	
C940	NONE	2.2/50	NONE	NONE	NONE	NONE	NONE	NONE	NONE	NONE	NONE	NONE	NONE	NONE	NONE	NONE	NONE	
DB15-DB16	NONE	MTZJ6-2C-T2	NONE	NONE	NONE	NONE	NONE	MTZJ6-2C-T2	NONE	NONE	NONE	NONE	NONE	NONE	NONE	MTZJ6-2C-T2	NONE	

NOTES
 1. VOLTAGES ARE DC-MEASURED WITH A DIGITAL VOLT METER OR OSCILLOSCOPE WITHOUT INPUT SIGNAL.
 CONDITION - AUX MODE- VOL. MIN- BASS LEVEL 1
 2. VALUES OTHERWISE SPECIFIED
 RESISTORS ARE 1/4W ± 5% CARBON RESISTOR.
 ALL RESISTANCE VALUES ARE IN OHMS.
 ALL CAPACITORS ARE OSRAM CAPACITOR OR MILAR CAPACITOR.
 ALL CAPACITANCE VALUES ARE IN #F(PF).
 ALL INDUCTANCE VALUES ARE IN #H(MH).
 ALL E-CAPACITORS ARE SHOWN IN THE FORM OF CAPACITANCE (#F/RATED VOLTAGE #V).
 ALL DIMENSIONS ARE 100±0.15

Parts are safety assurance parts.
 When replacing those parts make
 sure to use the specified one.

Front section

5

4

3

2

1

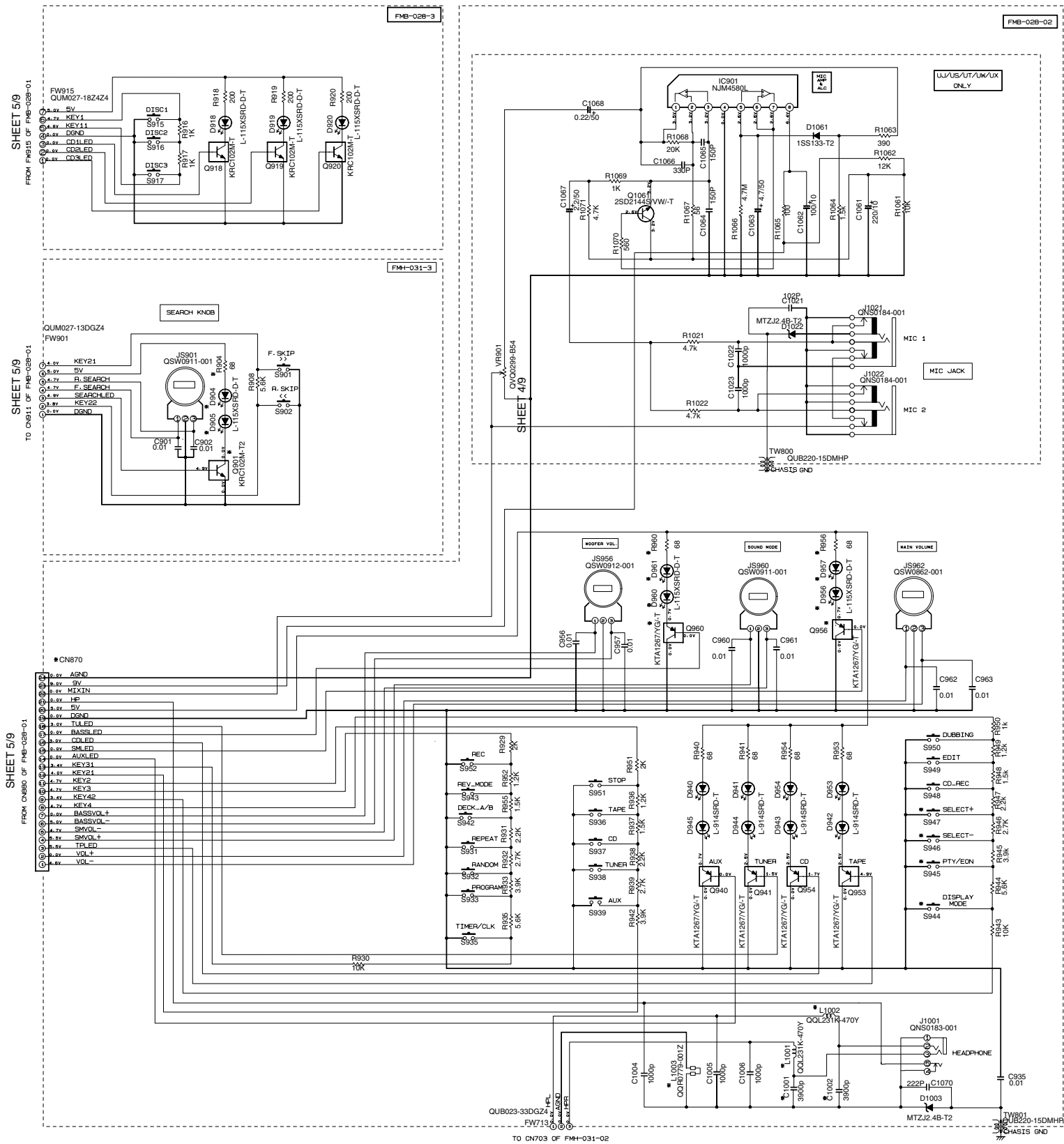

* MARK

	CA-MXG71R B-E-EN-EV	CA-MXG70 A	MX-G70 J-C	CA-MXG70 UX	CA-MXG70 UJ,UP,US,UT,UW	CA-MXG70 UY	MX-G71R EE	CA-MXG780 UJ,UP,US,UT,UW	MX-G780 C-J	CA-MXG791R B-E-EN-EV	MX-G791R EE	CA-MXG780 A	CA-MXG780 UY	CA-MXG780 UJ,UP,US,UT,UW	MX-G790 C-J	MX-G790 A	MX-G790 UY
D904, D905, D956, D957, D960, D961	NONE	NONE	NONE	NONE	NONE	NONE	NONE	NONE	L-115XSPD-D-T	NONE	L-115XSPD-D-T	NONE	NONE	L-115XSPD-D-T	L-115XSPD-D-T	L-115XSPD-D-T	L-115XSPD-D-T
S944, S945, S946, S947	QSW0825-001Z	NONE	NONE	NONE	NONE	NONE	QSW0825-001Z	NONE	NONE	QSW0825-001Z	QSW0825-001Z	NONE	NONE	NONE	NONE	NONE	NONE
L1001, L1002	QGL231K-470Y	QGL231K-470Y	SHORT	SHORT	SHORT	SHORT	QGL231K-470Y	SHORT	SHORT	QGL231K-470Y	QGL231K-470Y	SHORT	SHORT	SHORT	SHORT	SHORT	QGL231K-470Y
C1001, C1002	3900P	3900P	NONE	NONE	NONE	NONE	3900P	NONE	NONE	3900P	3900P	NONE	NONE	NONE	NONE	NONE	3900P
L1003	QGR0779-001Z	QGR0779-001Z	QGL231K-2R2Y	QGL231K-2R2Y	QGL231K-2R2Y	QGL231K-2R2Y	QGR0779-001Z	QGL231K-2R2Y	QGL231K-2R2Y	QGR0779-001Z	QGR0779-001Z	QGR0779-001Z	QGL231K-2R2Y	QGL231K-2R2Y	QGL231K-2R2Y	QGL231K-2R2Y	QGL231K-2R2Y
R904, R956, R960	NONE	NONE	NONE	NONE	NONE	NONE	68	NONE	68	NONE	68	NONE	NONE	68	68	68	68
G901	NONE	NONE	NONE	NONE	NONE	NONE	KRC102M-T	KRC102M-T	KRC102M-T	NONE	NONE	NONE	NONE	KRC102M-T	KRC102M-T	KRC102M-T	KRC102M-T
CN870	GGF1205F1-22	GGF1205F1-22	GGF1205F1-22	GGF1205F1-24	GGF1205F1-24	GGF1205F1-24	GGF1205F1-22	GGF1205F1-22	GGF1205F1-22	GGF1205F1-22	GGF1205F1-22	GGF1205F1-22	GGF1205F1-22	GGF1205F1-22	GGF1205F1-22	GGF1205F1-24	GGF1205F1-24
G956, G960	NONE	NONE	NONE	NONE	NONE	NONE	NONE	KTA1266/YG-T	NONE	KTA1266/YG-T	KTA1267/YG-T	NONE	NONE	KTA1267/YG-T	KTA1267/YG-T	KTA1267/YG-T	KTA1267/YG-T

NOTES
 1. VOLTAGES ARE DC-MEASURED WITH A DIGITAL VOLT METER OR OSCILLOSCOPE WITHOUT INPUT SIGNAL.
 CONDITION - AUX MODE, VOL MD= BASS OFF
 2. UNLESS OTHERWISE SPECIFIED:
 ALL CAPACITORS ARE CERAMIC CAPACITOR OR MYLAR CAPACITOR.
 ALL RESISTANCE VALUES ARE IN OHMS.
 ALL CAPACITANCE VALUES ARE IN #F/P#F1.
 ALL INDUCTANCE VALUES ARE IN #H/#MH#H.
 ALL E-CAPACITORS ARE SHOWN IN THE FORM OF CAPACITANCE (#F1/RATED VOLTAGE (V)).
 ALL DIMENSIONS ARE IN MILLIMETERS.

CD serbo section

5

4

3

2

1

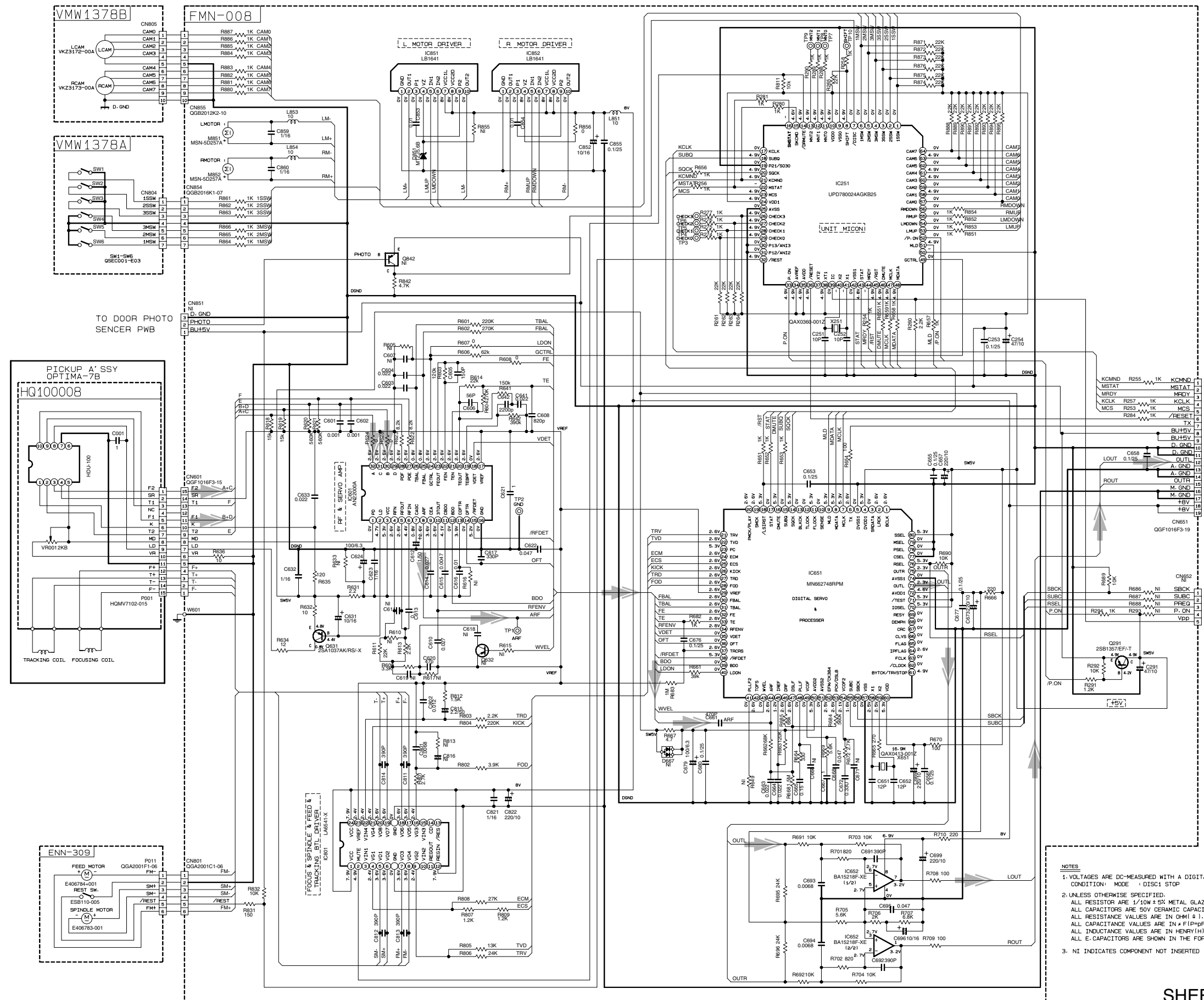

TO CN651 OF FMC-022-1 SHEET 4/9

- NOTES
1. VOLTAGES ARE DC-MEASURED WITH A DIGITAL VOLT METER
CONDITION: MODE : DISC1 STOP
 2. UNLESS OTHERWISE SPECIFIED:
ALL RESISTOR ARE 1/10W ± 5% METAL GLAZE RESISTOR.
ALL CAPACITORS ARE 50V CERAMIC CAPACITOR OR 50V MYLAR CAPACITOR.
ALL RESISTANCE VALUES ARE IN OHM ± 1%.
ALL CAPACITANCE VALUES ARE IN nF (pF × 1000).
ALL INDUCTANCE VALUES ARE IN HENRY (H).
ALL E. CAPACITORS ARE SHOWN IN THE FORM OF CAPACITANCE (nF) / RATED VOLTAGE (V).
 3. NI INDICATES COMPONENT NOT INSERTED

Head amplifier section

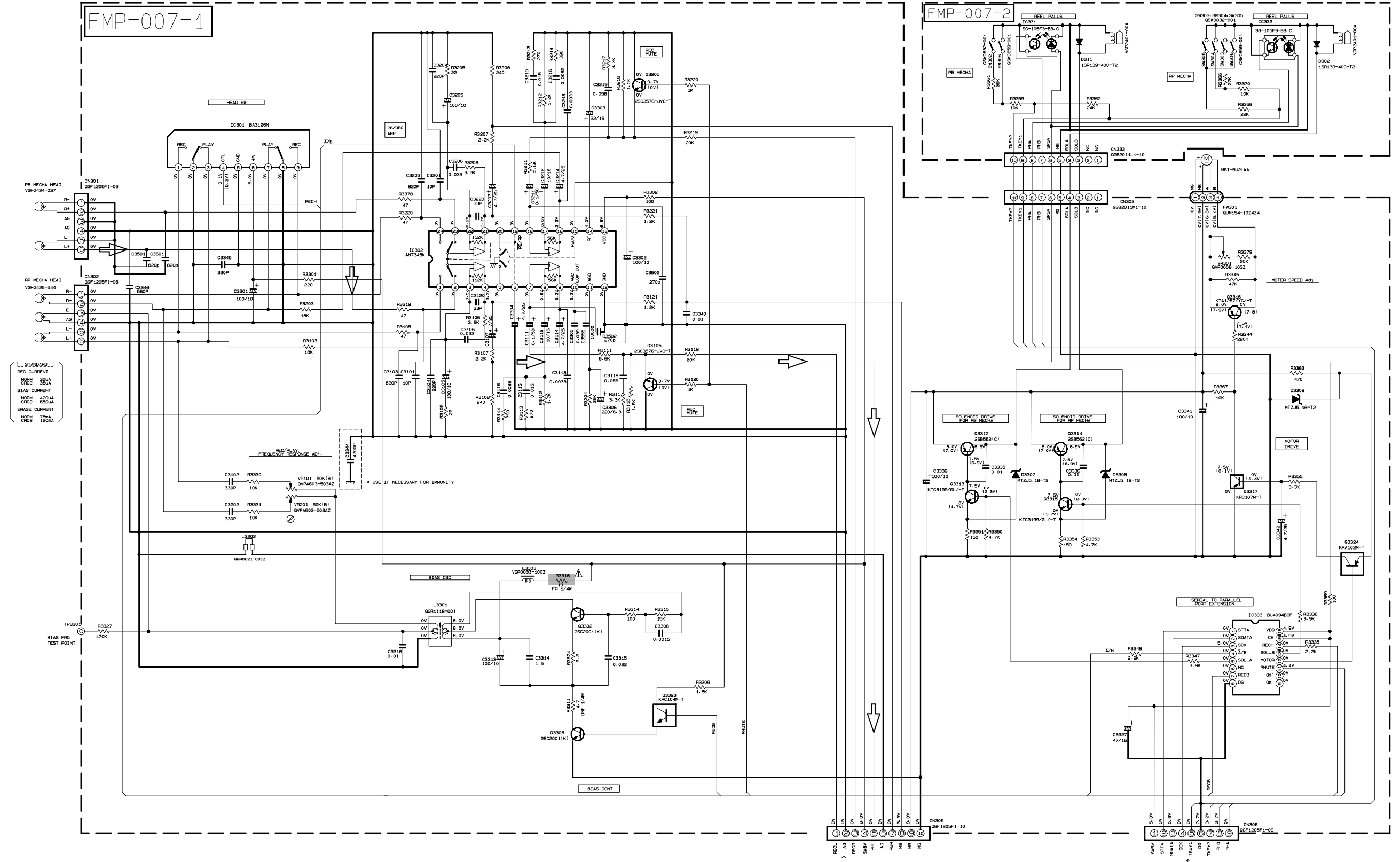

- NOTES
1. VOLTAGES ARE DC-MEASURED WITH A DIGITAL VOLT METER OR OSCILLOSCOPE WITHOUT INPUT SIGNAL. () IS INVERT MODE
 2. UNLESS OTHERWISE SPECIFIED
 - ALL RESISTANCE VALUES ARE IN Ω (Ω).
 - ALL CAPACITANCE VALUES ARE IN μ (μ).
 - ALL CAPACITANCE VALUES ARE IN pF(μ pF).
 - ALL INDUCTANCE VALUES ARE IN μ H(μ mH).
 - ALL E. CAPACITORS ARE SHOWN IN THE FORM OF CAPACITANCE (μ F)/RATED VOLTAGE (V).
 - PP PLYPROPYLENE CAPACITOR

SHEET4/9

SHEET5/9

FROM CN315 OF FMC-022-1

FROM CN316 OF FMB-028-1

Parts are safety assurance parts. When replacing those parts make sure to use the specified one.

TAPE P.B. signal SHEET 8/9

5
4
3
2
1

Tuner section

NOTES

- VOLTAGES ARE DC-MEASURED WITH A DIGITAL VOLT METER.
- ALL RESISTORS ARE 1/8W ±5% METAL GLAZE RESISTOR.
- ALL RESISTANCE VALUES ARE IN OHM(Ω).
- ALL CAPACITANCE VALUES ARE IN #F(P=PF).
- ALL E. CAPACITORS ARE SHOWN IN THE FORM OF CAPACITANCE (#F)/RATED VOLTAGE (V).
- SI DIODES (▶) ARE ALL 1S133-T THAT CAN BE CHANGED TO SIMILAR DIODE SUCH AS MA169 OR HSS104J.
- PARTS NO. OF TRANSISTORS ARE AS FOLLOWS:
Q1 2SC2814/4-5/-X Q2, Q3 2SC2412K/R/-X
Q4, Q5 DTA114YKA-X

B. INSIDE OF DIGITAL TRANSISTORS ARE SHOWN AS FOLLOWS:

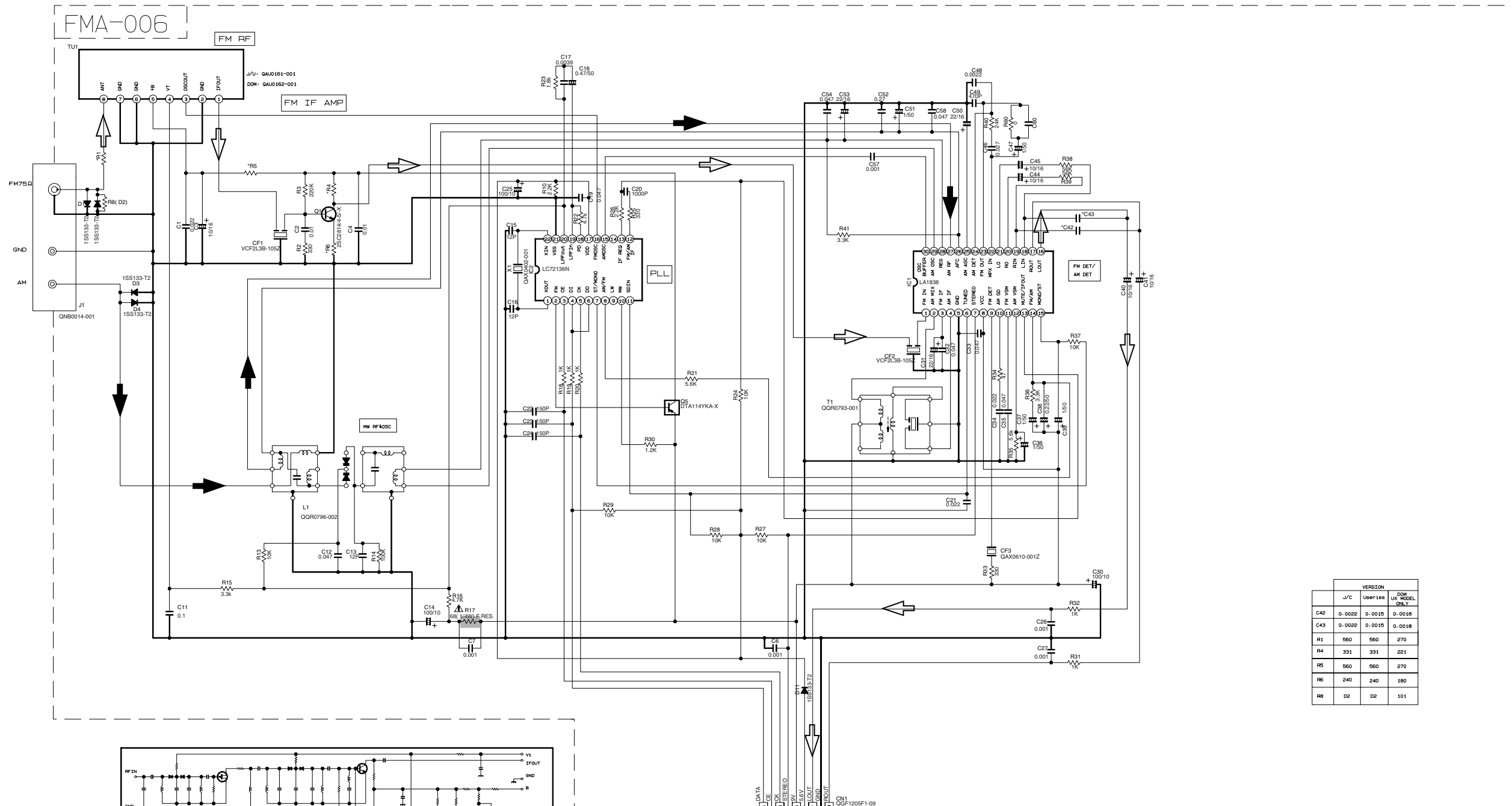
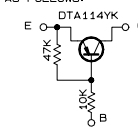

	VERSION		
	J/C	UMP149	CGM IX MODEL 024.Y
C42	0.0022	0.0015	0.0018
C43	0.0022	0.0015	0.0018
R1	560	560	270
R4	331	331	221
R5	560	560	270
R6	240	240	180
R8	02	02	101

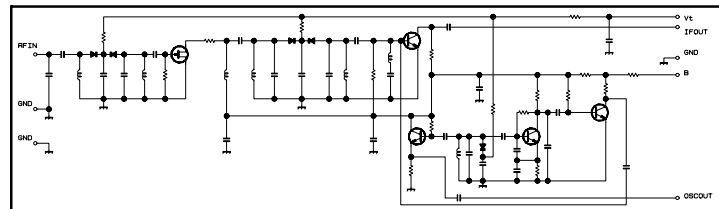

CONDITION	PIN NO.	1	2	3	4	5	6	7	8	9	10	11	12	13	14	15	16	17	18	19	20	21	22	23	24	25	26	27	28	29	30
IC1	FM NO SIGNAL	3.6	8.9	3.6	3.6	0	5.0	5.0	8.9	8.9	1.3	0.1	0.0	0.9	7.8	7.8	4.3	4.3	4.3	4.3	3.4	3.4	2.8	3.4	0	0	3.6	3.6	3.6	2.7	
	AM NO SIGNAL	3.5	9.0	3.5	3.5	0	5.0	5.1	9.0	2.6	1.3	0	0	0.9	4.7	5.5	4.3	4.3	4.3	4.3	3.3	3.2	2.8	1.8	0.7	0.7	3.6	3.6	3.6	2.1	
IC2	FM NO SIGNAL	2.5	0	0	5.0	4.9	5.0	7.9	7.8	3.6	6.1	5.1	0	0	0	0	2.5	5.1	0.9	0.9	3.8	0	2.3								

FROM CN732 OF FMB-012-1 SHEET 4/9

Tr. NO.	Q1	Q5	
PIN NO.	E C B E C B	E C B E C B	
FM 87.5MHz NO SIGNAL	0 7.1 0.85	8.9 8.8 0	
AM 522kHz NO SIGNAL	0 0 0 9.0	0 8.9	
Tr. NO.	Q2	Q3	Q4
PIN NO.	E C B E C B E C B	E C B E C B	E C B
FM 87.5MHz NO SIGNAL	0 0 0 7.0	0 0 0 7.0	0 3.6 0.7
AM 522kHz NO SIGNAL	0 0 0 0.3	0 0.3 0.3	3.6 3.6 3.6

▲ Parts are safety assurance parts. When replacing those parts make sure to use the specified one.

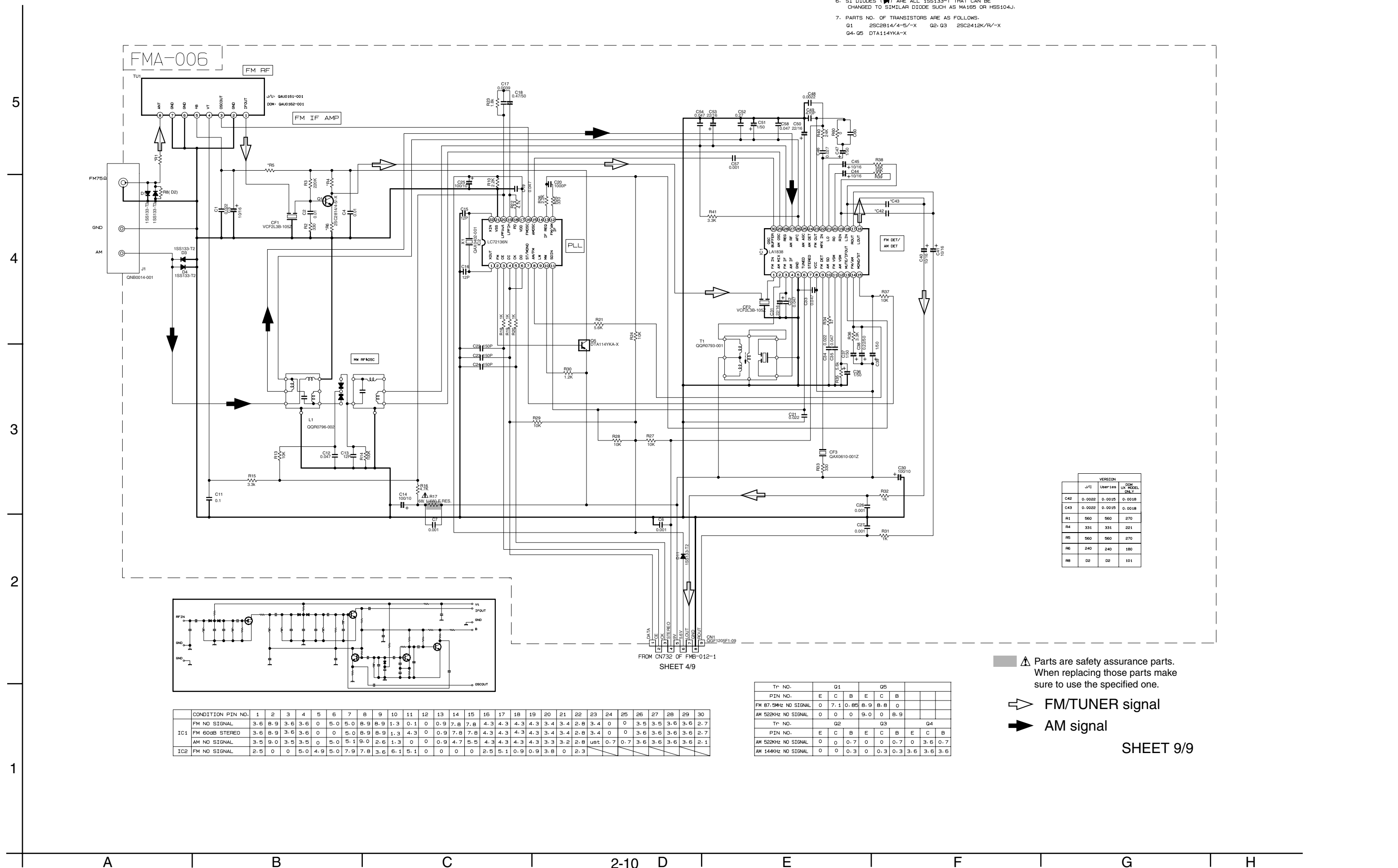
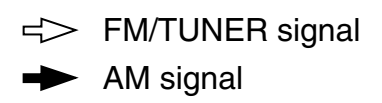

Printed circuit boards

■ Main board

5

4

3

2

1

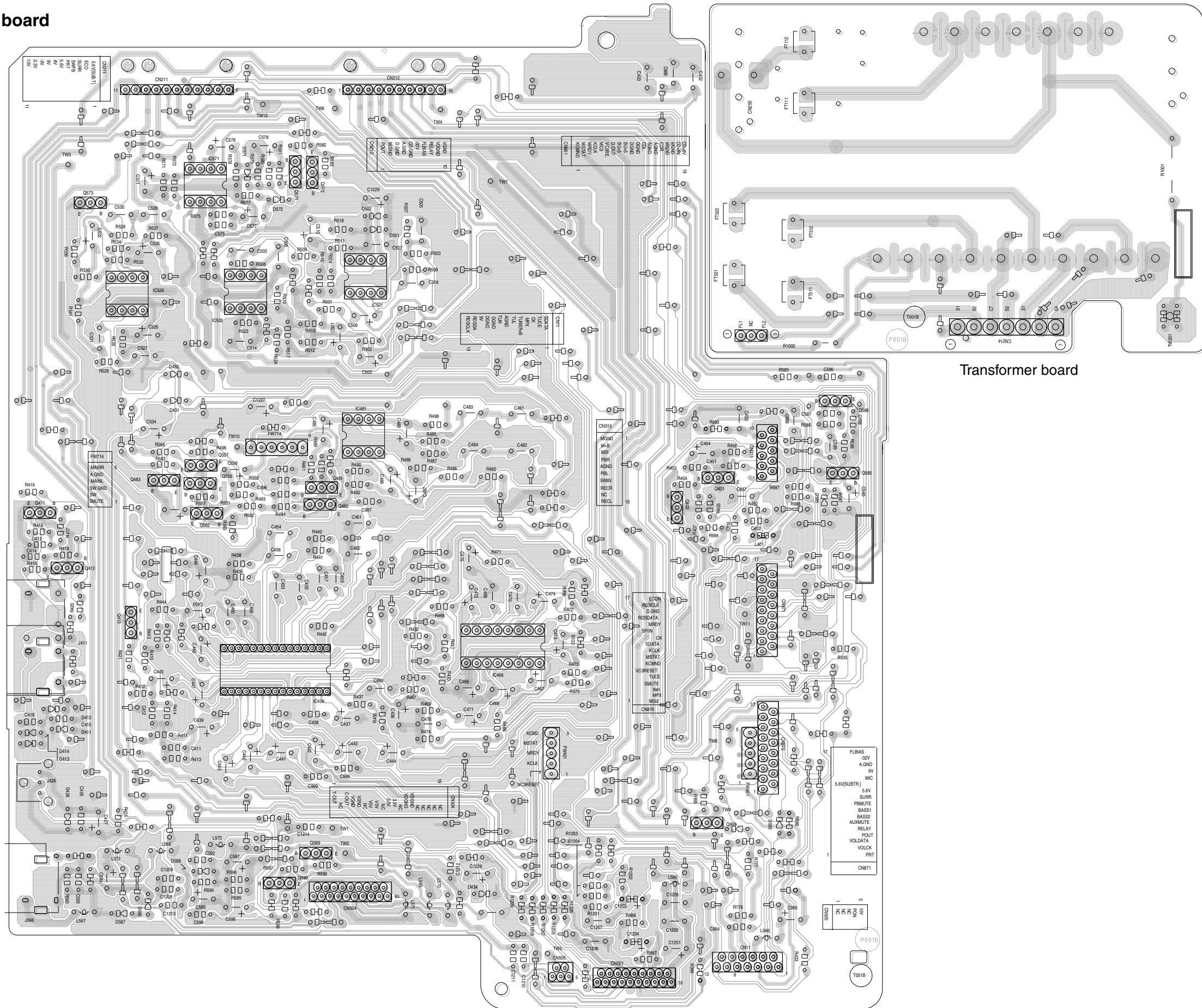

Transformer board

A B C D E F G

■ Regulation & amplifier board

5

4

3

2

1

Regulation board

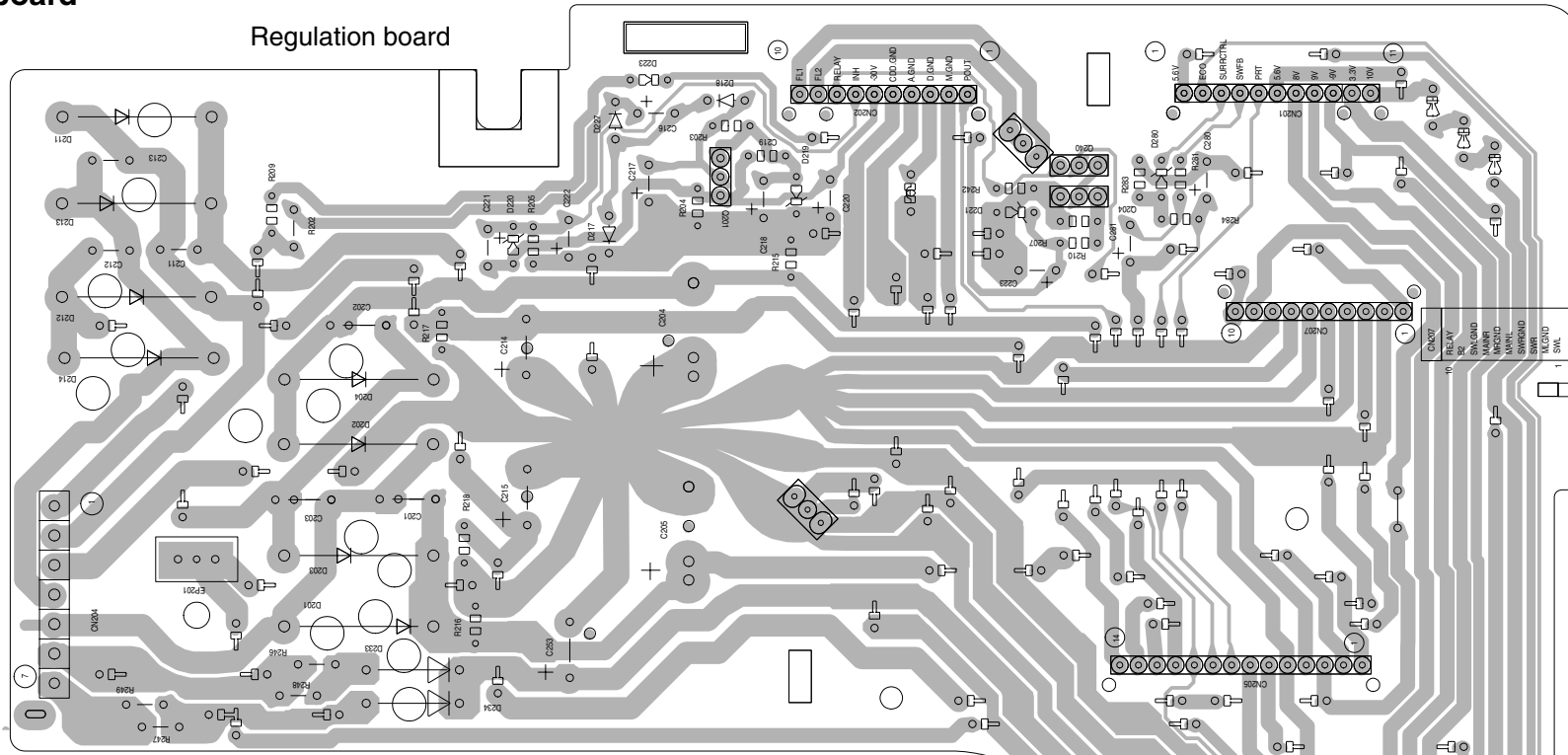

Preset/tuning switch board

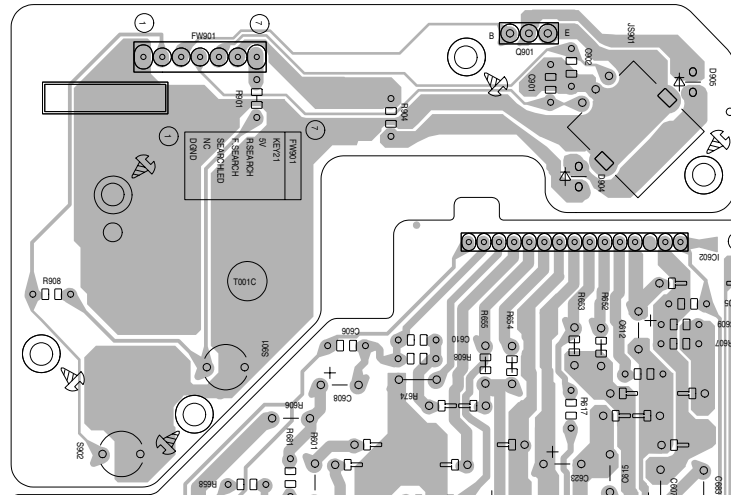

Amplifier board

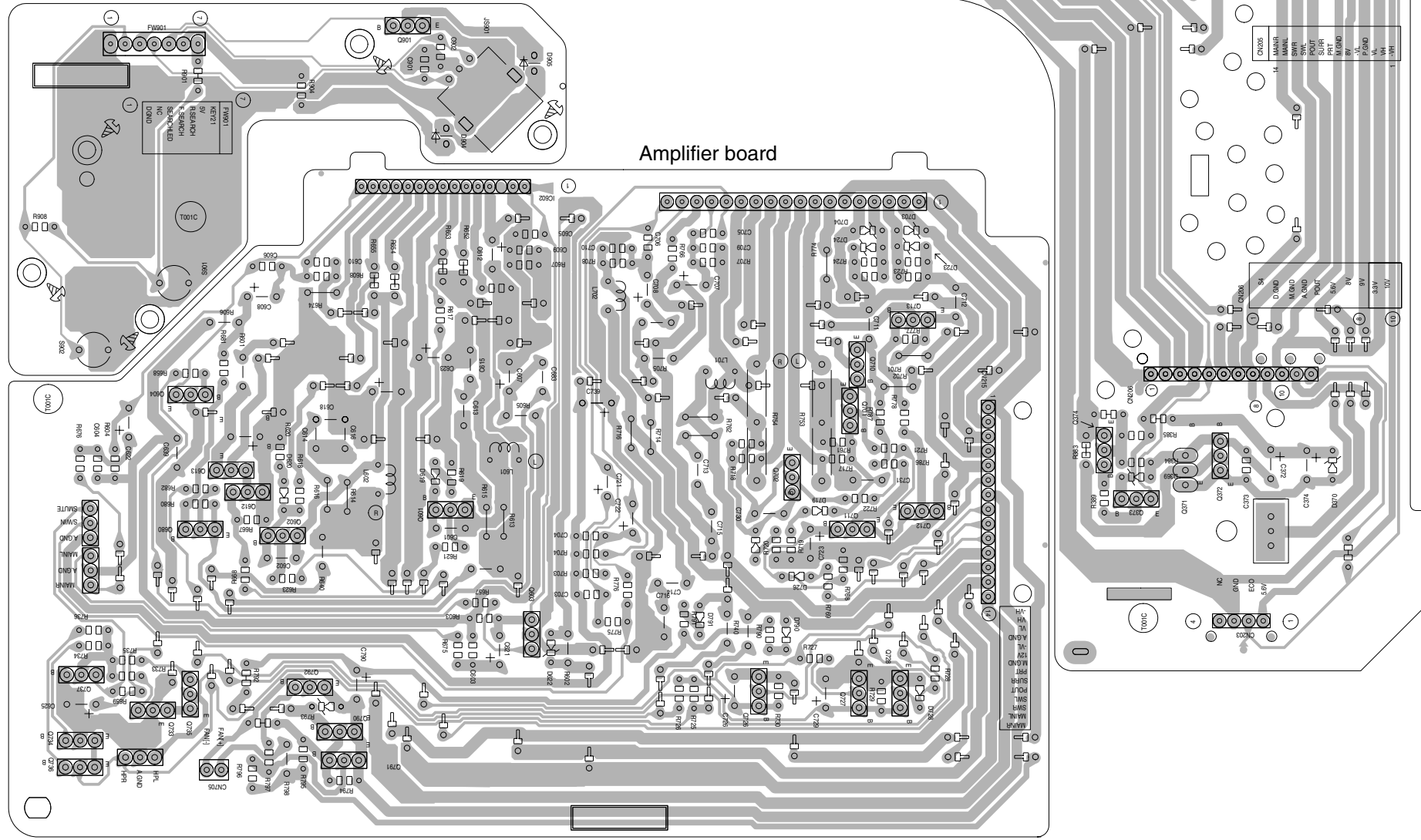

A

B

C

2-12 D

E

F

G

H

■ Front board

Display & system control board

Operation switch board

5

4

3

2

1

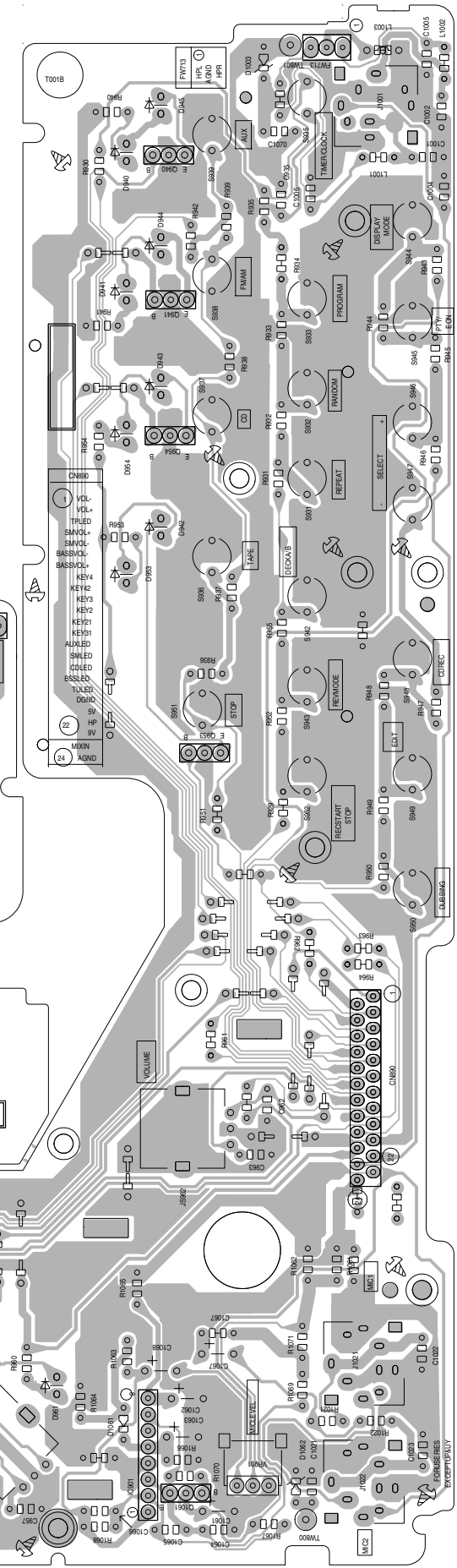
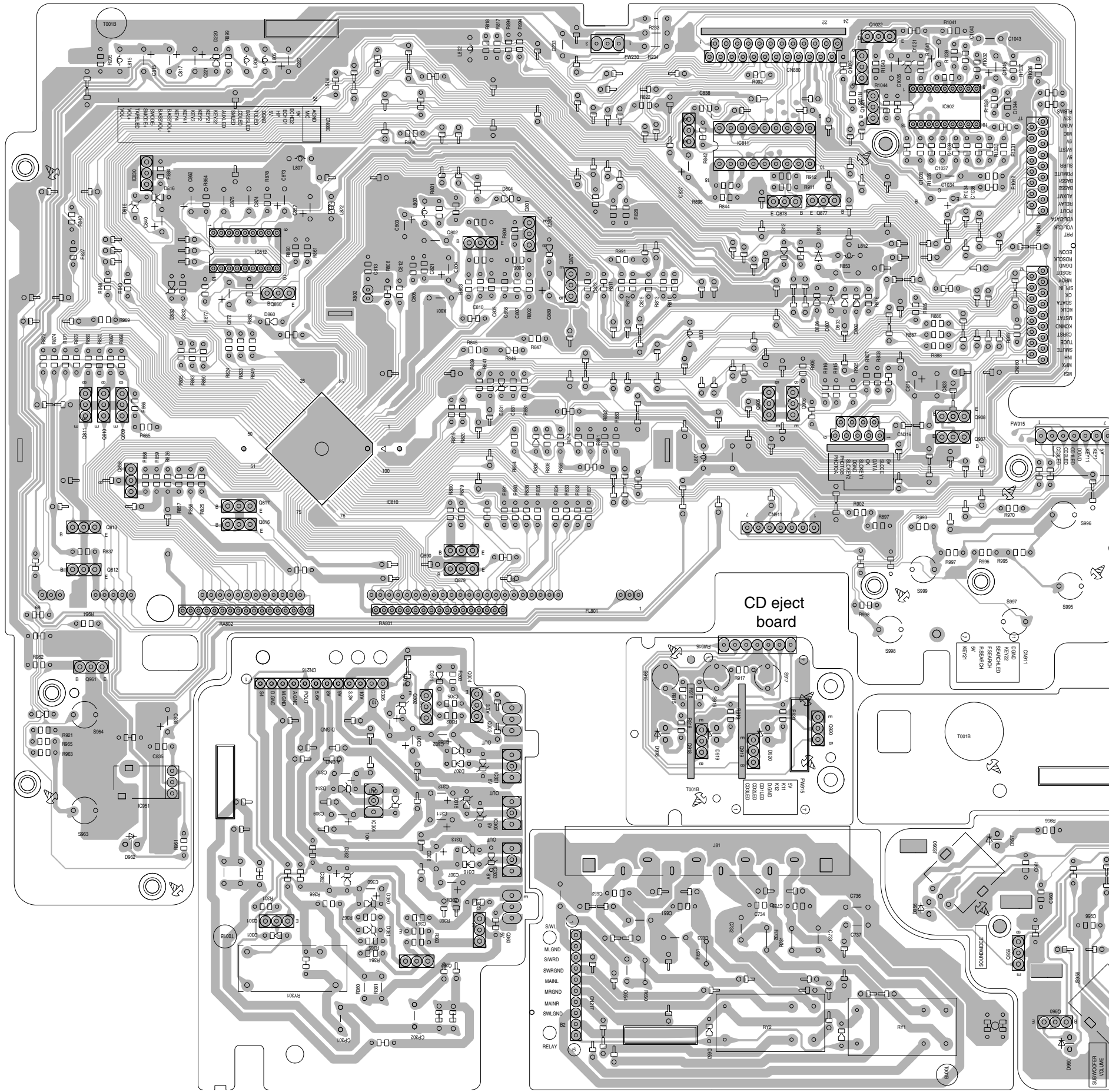

A

B

C

D

E

F

G

■ CD servo control board

■ Head amplifier & mechanism control board

■ Tuner board

5

4

3

2

1

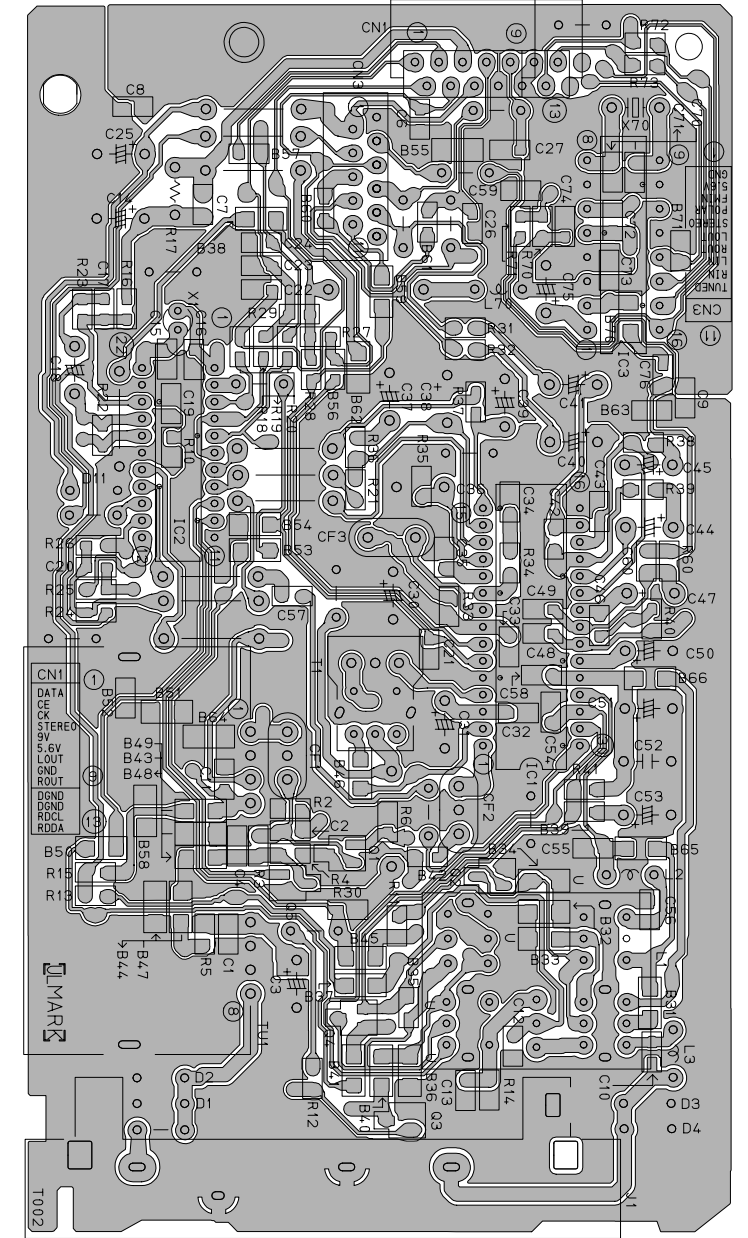
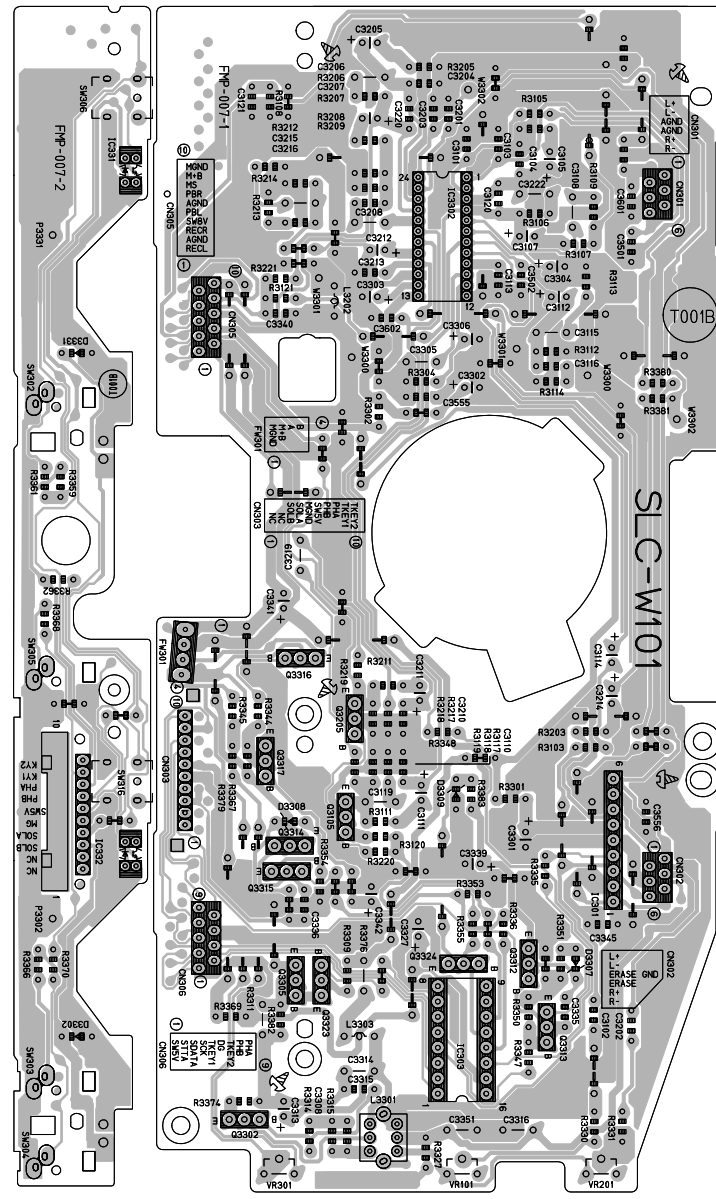
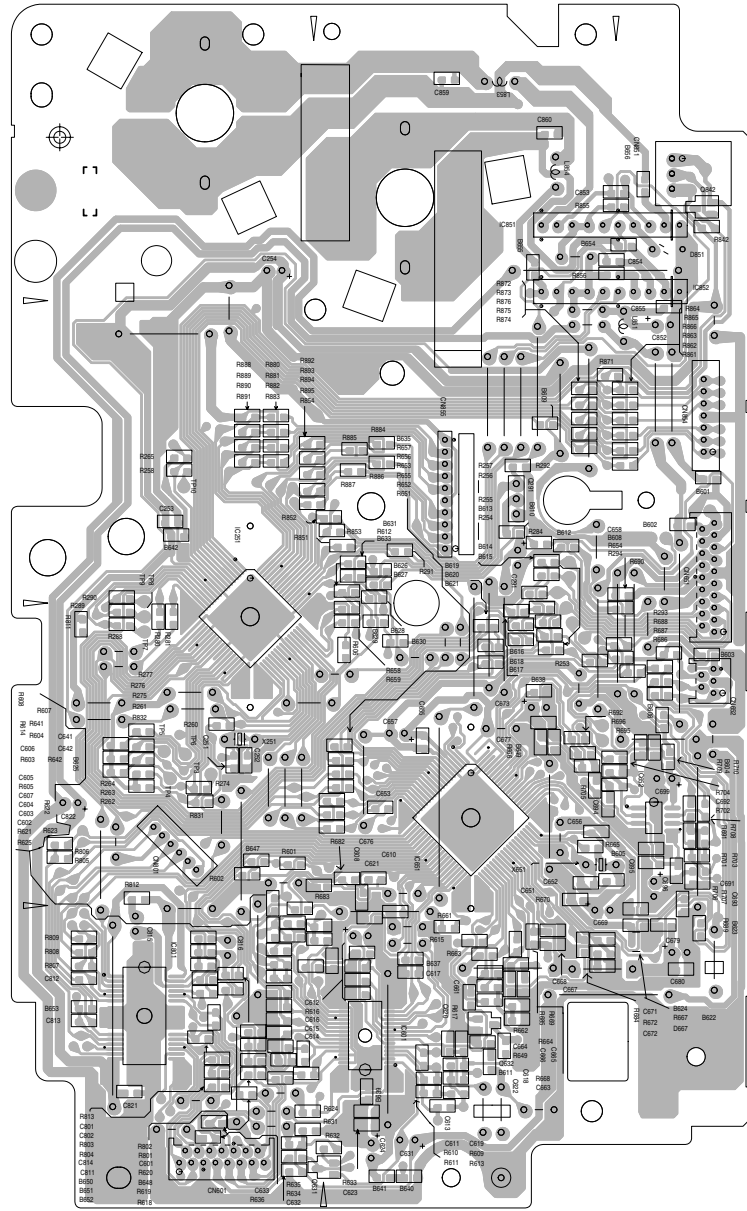

A

B

C

2-14 D

E

F

G

H